

2 Poles

TYPE	PUMP			
	CM	CMG	CA	CAX
32-160C	●	×	●	●
32-160B	●	×	●	●
32-160A	●	×	●	●
32-200C	●	×	●	●
32-200B1	●	×	×	●
32-200B	●	×	●	●
32-200A1	●	×	×	●
32-200A	●	×	●	●
32-250C	●	×	●	●
32-250B	●	×	●	●
32-250A	●	×	●	●
40-125C	●	×	●	●
40-125B	●	×	●	●
40-125A	●	×	●	●
40-160B	●	×	●	●
40-160A	●	×	●	●
40-160AP	●	×	●	●
40-200B1	●	×	-	●
40-200B	●	×	●	●
40-200A1	●	×	×	●
40-200A	●	×	●	●
40-200AP	●	×	●	●
40-250C	●	×	●	●
40-250B	●	×	●	●
40-250A	●	×	●	●
40-250BM	●	×	●	●
40-250AM	●	×	●	●
50-125B	●	×	●	●
50-125A	●	×	●	●
50-160B1	●	×	×	●
50-160B	●	×	●	●
50-160A1	●	×	×	●
50-160A	●	×	●	●
50-200C	●	×	●	●
50-200B	●	×	●	●
50-200A	●	×	●	●
50-250C	●	×	●	●
50-250B	●	×	●	●
50-250A	●	×	●	●
50-315DN	×	×	●	×
50-315CN	×	×	●	×
50-315BN	×	×	●	×
50-315AN	×	×	●	×
65-125B1	●	×	×	●
65-125B	●	×	●	●
65-125A1	●	×	×	●
65-125A	●	×	●	●
65-160C	●	×	●	●
65-160B	●	×	●	●
65-160A	●	×	●	●
65-200C	●	×	●	●
65-200B	●	×	●	●
65-200A	●	×	●	●
65-250B	●	×	●	●
65-250A	●	×	●	●
65-315CN	×	×	●	×
65-315BN	×	×	●	×
65-315AN	×	×	●	×

TYPE	PUMP			
	CM	CMG	CA	CAX
80-160E	●	×	●	●
80-160D	●	×	●	●
80-160C	●	×	●	●
80-160B	●	×	●	●
80-160A	●	×	●	●
80-200B	●	×	●	●
80-200A	●	×	●	●
80-250B	×	●	●	●
80-250A	×	●	●	●
80-315BN	×	×	●	×
80-315AN	×	×	●	×
100-160B	●	×	×	●
100-160B	●	×	×	●
100-200B	×	●	●	●
100-200A	×	●	●	●
100-250C	×	●	●	●
100-250B	×	●	●	●
100-250A	×	●	●	●

●=Available
×=Not available

Legend

CM: Front suction close-coupled centrifugal pumps with close impeller mounted on IE3 motor shaft extension. Pump casing with axial suction and radial delivery on top, main dimensions and performance according to EN 733.

CMG: Front suction centrifugal pumps connected to IE3 standard motor (stub-shaft construction). Pump casing with axial suction and radial delivery on top, main dimensions and performance according to EN 733.

CA-CAX: Single-stage end-suction centrifugal frame-mounted pumps. Dimensions in accordance with EN 733.

CM Series

Models list and materials

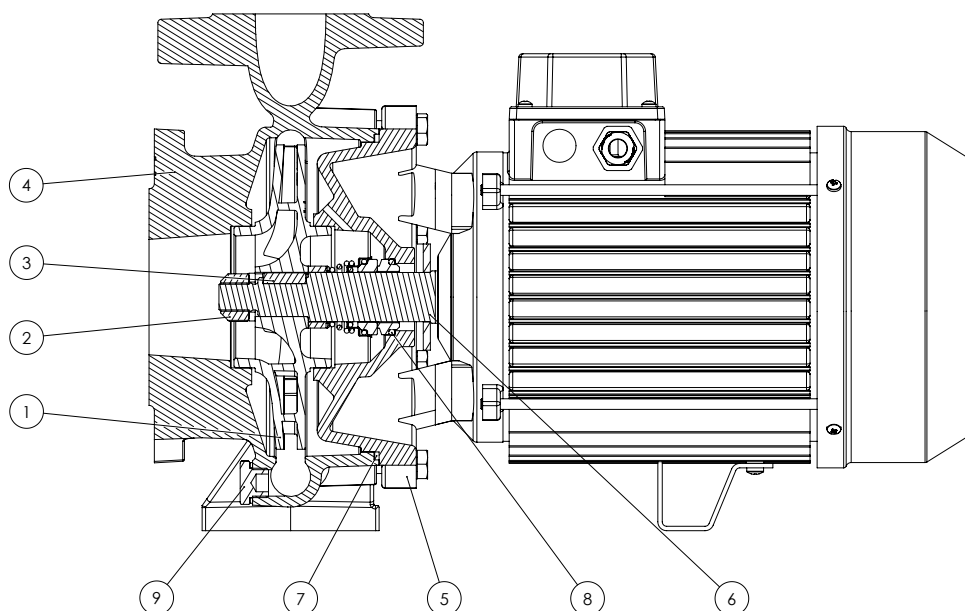

POS. N.	DENOMINATION	VERSION	MATERIAL	REFERENCE STANDARDS	
				EUROPE	USA
1	Impeller	Standard B X	Cast iron G20 Bronze Stainless steel	GJL-200 (JL1030) CuSn10-C (CC480K) X5CrNiMo17-12-2/ 1.4401	ASTM Class 30 UNS C90700 AISI 316
2	Impeller lock nut and washer		Stainless steel	X5CrNiMo17-12-2/ 1.4401	AISI 316
3	Impeller key		Stainless steel	X5CrNiMo17-12-2/ 1.4401	AISI 316
4	Volute casing	Standard for models up to 80-200 Standard from model 80-250	Cast iron G20 Cast iron G25	GJL-200 (JL1030) GJL-250 (JL1040)	ASTM Class 30 ASTM Class 35
5	Motor bracket		Cast iron G20	GJL-200 (JL1030)	ASTM Class 30
6	Shaft extension		Stainless steel	X5CrNi18-10/ 1.4301	AISI 304
7	O-ring	Standard E V	NBR EPDM FKM		
8	Mechanical seal		(Search for the material in the mechanical seal table)		
9	Fill and drain plugs		Brass	CU ZN 40 PB2 UNI 5705/65	C37700



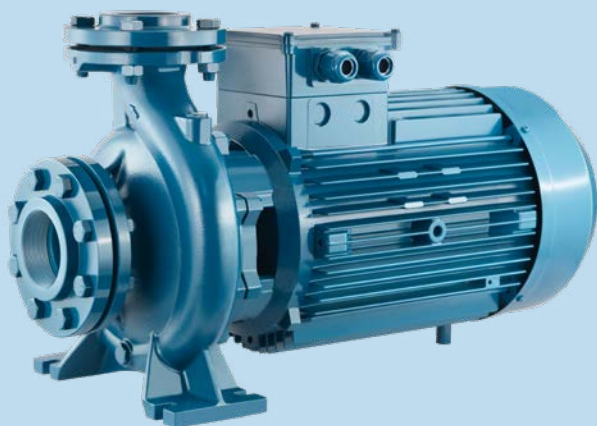

Monobloc horizontal centrifugal pumps, constructed in compliance with EN 733 standards; widely used in water supplies, pressurisation and fire-fighting systems, cooling, heating, irrigation, industrial and agricultural applications; standard supply with counter-flange.

Construction features

Pump body	cast iron
Motor bracket	cast iron
Impeller	cast iron, bronze or stainless steel
Mechanical seal	ceramic-graphite-NBR
Pump shaft end	stainless steel AISI 304
Liquid temperature	-10 ÷ +90 °C
Operating pressure	max 10 bar

Motor

2 Poles induction motor	3~ 230/400V-50Hz P ≤ 4kW 3~ 400/690V-50Hz P > 4kW
	1~ 230V-50Hz
Insulation class	F
Protection degree	IPX5

CM 50-160A-B

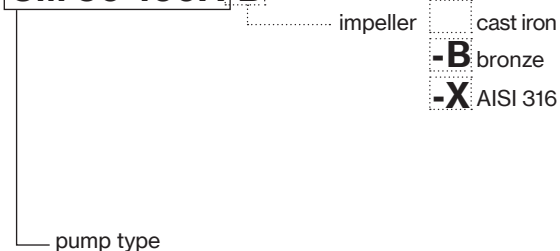

TYPE	LOTS			
	TRUCK		CONTAINER	
	PALLET (cm)	N° pumps	PALLET (cm)	N° pumps
32-160	80×120×155	24	80×120×190	30
32-200 C	80×120×155	24	80×120×180	24
32-200 A/B	100×120×140	18	100×120×185	24
32-250 A	85×110×120	6	85×110×170	9
32-250 B/C	80×120×120	6	80×120×170	9
40-125	80×120×155	24	80×120×190	30
40-160	80×120×155	24	80×120×190	30
40-200	100×120×140	18	100×120×185	24
40-250 A	85×110×120	6	85×110×170	9
40-250 B/C	80×120×120	6	80×120×170	9
50-125	80×120×120	24	80×120×180	24
50-160	100×120×140	18	100×120×185	24
50-200 A	85×110×120	6	85×110×170	9
50-200 B/C	80×120×120	6	80×120×170	9
50-250	80×120×120	6	80×120×170	9
65-125	100×120×140	18	100×120×185	24
65-160	85×110×120	6	85×110×170	9
65-200	85×110×120	6	85×110×170	9
65-250	85×110×130	4	85×110×190	6
80-160	85×110×120	6	85×110×170	9
80-200	85×110×130	4	85×110×190	6

TYPE	P ₂ nom.		1~		3~		Q (m ³ /h - l/min)																				
			P ₁ max kW	A 1x230V 50Hz	P ₁ max kW	A 3x400V 50Hz	0	6	7,5	9	12	15	18	21	24	27	30	33									
	HP	kW					H (m)																				
							0	100	125	150	200	250	300	350	400	450	500	550									
32-160C	2	1,5	2,0	9,3	1,9	3,6	23,0	22,8	22,5	22,0	21,0	19,2	16,9	14,0													
32-160B	3	2,2	2,7	12,4	2,6	4,9	28,0	27,7	27,4	27,0	26,2	24,9	22,9	20,1	17,0												
32-160A	4	3	-	-	3,8	6,8	36,1	36,2	36,0	35,6	34,6	33,2	31,4	28,9	25,7	22,1											
32-200C	5,5	4	5,2	22,9	4,9	8,9	40,2	40,3	40,1	39,8	38,9	37,7	36,1	34,2	31,6	28,7											
32-200B1	7,5	5,5	-	-	6,4	11,3	48,3	48,0	47,9	47,6	46,7	45,5	44,2	42,6	40,5	37,9											
32-200B	7,5	5,5	-	-	6,7	11,1	48,3	48,0	47,9	47,6	46,7	45,5	44,2	42,6	40,5	37,9	35,4										
32-200A1	10	7,5	-	-	8,2	14,5	57,9	58,3	58,4	58,4	58,0	57,1	55,6	53,8	51,4	49,2	46,6										
32-200A	10	7,5	-	-	8,6	14,1	57,9	58,3	58,4	58,4	58,0	57,1	55,6	53,8	51,4	49,2	46,6	44,3									
32-250C	12,5	9,2	-	-	10,0	16,8	74,6		72,8	72,5	71,9	70,5	68,8	66,6	64,1	61,3											
32-250B	15	11	-	-	12,2	20,0	84,8		84,0	83,9	83,6	82,7	81,1	78,6	75,4	73,2											
32-250A	20	15	-	-	13,5	23,2	93,5		93,6	93,7	93,7	93,4	92,3	90,4	87,7	85,3											

TYPE	P ₂ nom.		1~		3~		Q (m ³ /h - l/min)																						
			P ₁ max kW	A 1x230V 50Hz	P ₁ max kW	A 3x400V 50Hz	0	9	12	15	18	21	24	27	30	33	36	39	42	45	48	54	60						
	HP	kW					H (m)																						
							0	150	200	250	300	350	400	450	500	550	600	650	700	750	800	900	1000						
40-125C	2	1,5	2,0	9,3	1,9	3,6	17,9	18,5	18,4	18,1	17,5	16,6	15,6	14,3	12,8	11,1	9,4												
40-125B	3	2,2	2,7	12,4	2,6	4,9	22,6	23,4	23,3	23,1	22,7	22,0	21,0	19,9	18,6	17,0	15,1	13,2											
40-125A	4	3	-	-	3,6	6,5	26,8	27,6	27,7	27,6	27,2	26,5	25,7	24,6	23,4	22,0	20,3	18,5	16,8										
40-160B	4	3	3,8	16,7	3,8	6,8	28,2	29,2	29,2	28,9	28,3	27,5	26,5	25,3	23,8	22,3	20,5												
40-160A	5,5	4	5,0	22,5	4,9	8,8	33,8	34,9	34,8	34,5	33,9	33,2	32,4	31,3	30,0	28,5	26,9	25,2	23,4										
40-160AP	7,5	5,5	-	-	6,1	11,0	38,6	39,8	39,9	39,8	39,4	38,7	37,9	37,0	35,8	34,4	32,9	31,1	29,3	27,4	25,3								
40-200B1	7,5	5,5	-	-	6,8	12,0	44,7	45,5	45,4	45,0	44,5	43,5	42,3	41,0	39,3	37,2	34,9	32,3											
40-200B	7,5	5,5	-	-	6,9	11,4	44,6	45,5	45,4	45,0	44,5	43,5	42,3	41,0	39,3	37,2	34,9	32,3	29,4										
40-200A1	10	7,5	-	-	9,0	15,5	56,2	56,5	56,5	56,3	55,9	55,1	54,1	52,8	51,2	49,3	47,0	44,4											
40-200A	10	7,5	-	-	9,3	15,1	56,2	56,5	56,5	56,3	55,9	55,1	54,1	52,8	51,2	49,3	47,0	44,4	41,6										
40-200AP	12,5	9,2	-	-	10,2	16,8	61,7	61,4	61,2	60,8	60,0	59,1	57,9	56,4	54,7	53,1	51,1	48,5	45,5	42,2									
40-250C	12,5	9,2	-	-	11,1	18,0	64,8	64,4	64,2	63,8	63,4	62,7	61,9	61,0	59,8	57,9	55,4												
40-250B	15	11	-	-	13,8	22,3	73,7	73,9	74,5	73,2	71,9	71,1	70,2	69,2	68,1	66,7	64,7	62,1											
40-250A	20	15	-	-	17,5	29,1	82,6	84,6	84,8	84,7	84,3	83,4	82,4	81,3	80,0	78,5	76,9	75,4	72,8	69,0									
40-250BM max 14 bar	25	18,5	-	-	20,6	34,1	92,6	93,2	93,3	93,2	93,1	92,8	92,4	91,7	90,9	89,8	88,3	86,5	84,6	82,3	79,5	72,0							
40-250AM max 14 bar	30	22	-	-	24,4	40,3	101,7	103,0	102,8	102,3	102,2	102,0	101,7	101,2	100,4	99,4	98,1	96,5	94,8	93,1	90,9	85,0	77,5						

TYPE	P ₂ nom.		1~		3~		Q (m ³ /h - l/min)																								
			P ₁ max kW	A 1x230V 50Hz	P ₁ max kW	A 3x400V 50Hz	0	12	15	18	21	24	27	30	33	36	39	42	45	48	54	60	66	72	78						
	HP	kW					H (m)																								
							0	200	250	300	350	400	450	500	550	600	650	700	750	800	900	1000	1100	1200	1300						
50-125B	4	3	3,6	16,1	3,8	6,8	20,0	20,6	20,6	20,4	20,3	20,1	19,9	19,6	19,2	18,7	18,2	17,6	17,0	16,4	15,0	13,2	11,3	9,2							
50-125A	5,5	4	5,0	22,5	4,8	8,8	23,7	24,3	24,3	24,2	24,1	23,9	23,7	23,3	23,0	22,6	22,1	21,7	21,2	20,7	19,6	18,2	16,4	14,2							
50-160B1	7,5	5,5	-	-	6,5	11,4	32,1				33,5	33,4	33,1	32,7	32,2	31,6	31,0	30,2	29,2	28,3	26,2	23,9	21,5								
50-160B	7,5	5,5	-	-	6,5	10,9	32,1				33,5	33,4	33,1	32,7	32,2	31,6	31,0	30,2	29,1	28,3	26,2	23,9	21,5	18,9							
50-160A1	10	7,5	-	-	8,6	15,1	38,1				39,8	39,8	39,8	39,6	39,2	38,8	38,3	37,7	37,7	36,1	34,1	32,1	29,9	27,6							
50-160A	10	7,5	-	-	8,8	14,4	38,1				39,8	39,8	39,7	39,5	39,2	38,8	38,3	37,7	36,9	36,0	34,2	32,2	29,7	27,4	25,4						
50-200C	12,5	9,2	-	-	10,4	17,2	48,2				49,7	49,2	48,5	47,7	46,9	45,9	44,9	43,7	42,6	40,0	36,0	32,3	28,9								
50-200B	15	11	-	-	11,9	19,5	53,1				54,6	54,1	53,5	52,9	52,2	51,4	50,4	49,3	48,1	45,5	42,7	38,8	35,0								
50-200A	20	15	-	-	14,6	24,7	59,9				61,8	61,5	61,0	60,4	59,7	58,8	58,0	57,1	56,0	53,6	50,8	47,8	44,4	39,8							
50-250C	20	15	-	-	17,2	28,6	69,2					68,2	67,7	67,0	66,3	65,6	64,7	63,8	62,8	59,9	56,2	52,1									
50-250B	25	18,5	-	-	20,7	34,3	78,8					78,4	78,0	77,6	77,0	76,1	75,1	74,0	72,9	70,3	66,9	62,9	58,5								
50-250A	30	22	-	-	24,8	40,9	88,5					88,3	88,1	87,7	87,2	86,6	85,8	84,8	83,8	81,4	78,5	75,0	70,2	64,8							



TYPE	P ₂ nom.		3-		Q (m ³ /h - l/min)																				
			P ₁ max kW	A 3x400V 50Hz	0	30	33	36	39	42	45	48	54	60	66	72	78	84	96	108	120	132	138	144	150
	HP	kW			0	500	550	600	650	700	750	800	900	1000	1100	1200	1300	1400	1600	1800	2000	2200	2300	2400	2500
65-125B1	7,5	5,5	6,4	11,3	19,7	20,6	20,5	20,4	20,4	20,3	20,2	20,2	20,0	19,7	19,3	18,8	18,2	17,5	16,3	15,0					
65-125B	7,5	5,5	6,6	11,0	19,7	20,6	20,5	20,4	20,4	20,3	20,2	20,2	20,0	19,7	19,3	18,8	18,2	17,5	16,3	15,0	13,1				
65-125A1	10	7,5	8,6	15,1	24,6	25,2	25,2	25,1	25,1	25,0	24,8	24,9	24,7	24,5	24,2	23,9	23,5	23,0	22,0	20,6	18,8				
65-125A	10	7,5	8,8	14,4	24,6	25,2	25,2	25,1	25,1	25,0	24,9	24,9	24,7	24,5	24,2	23,9	23,5	23,0	22,0	20,6	18,8	16,8			
65-160C	12,5	9,2	10,1	16,8	28,9					30,6	30,5	30,3	30,0	29,6	29,1	28,5	27,9	27,2	25,3	22,9	20,2	17,5	16,0	13,9	
65-160B	15	11	12,7	20,6	33,2					35,1	35,0	34,9	34,6	34,3	33,8	33,3	32,8	32,1	30,4	28,2	25,5	22,5	21,4	20,4	
65-160A	20	15	17,1	28,5	40,1					42,5	42,5	42,5	42,3	42,1	41,8	41,4	41,0	40,4	38,9	37,1	35,3	32,8	31,7	30,9	
65-200C	20	15	17,0	28,3	44,4								46,1	45,4	44,7	44,0	43,2	42,4	40,3	37,5	33,7	28,9	26,8		
65-200B	25	18,5	21,2	34,8	51,7								53,9	53,4	52,7	52,0	51,3	50,4	48,6	45,9	43,0	39,4	37,1	34,6	
65-200A	30	22	25,4	41,7	60,3								61,8	61,4	61,0	60,4	59,8	59,1	57,1	54,6	51,6	48,3	46,5	44,4	
65-250B	40	30	30,8	55,3	80,6								80,6	79,5	78,4	77,1	75,7	74,1	70,4	66,1	61,0	54,7	51,0	47,3	
65-250A	50	37	37,0	69,2	91,6								91,6	90,8	89,8	88,6	87,4	85,9	82,5	77,8	72,8	67,4	64,3	60,8	57,9

TYPE	P ₂ nom.		3-		Q (m ³ /h - l/min)																			
			P ₁ max kW	A 3x400V 50Hz	0	66	72	78	84	96	108	120	132	138	144	156	168	180	195	210	225	240		
	HP	kW			0	1100	1200	1300	1400	1600	1800	2000	2200	2300	2400	2600	2800	3000	3250	3500	3750	4000		
80-160E	12,5	9,2	9,8	16,3	21,5	22,9	22,5	22,1	21,6	20,8	19,9	18,9	17,7	17,2	16,6	15,3	13,7							
80-160D	15	11	12,2	20,0	25,4	27,3	27,0	26,6	26,3	25,4	24,5	23,5	22,4	21,8	21,2	19,9	18,3	16,4						
80-160C	20	15	14,5	24,5	29,0	30,9	30,7	30,4	30,1	29,4	28,5	27,4	26,3	25,8	25,3	24,1	22,5	20,7	18,4					
80-160B	25	18,5	18,1	30,3	33,6	35,9	35,7	35,4	35,2	34,5	33,7	32,9	32,0	31,6	31,1	30,0	28,6	27,0	24,5	22,0				
80-160A	30	22	22	37	38	40,5	40,4	40,2	40,1	39,6	39,1	38,4	37,5	37,1	36,6	35,4	34,1	32,6	30,4	28,3	23,9			
80-200B	40	30	32,0	57,2	50,4				54,5	53,9	53,2	52,3	51,3	50,7	50,2	48,9	47,4	45,8	43,4	40,9	38,5			
80-200A	50	37	38,6	71,6	57,3				61,7	61,3	60,6	59,4	58,2	57,8	57,5	56,8	55,4	53,7	51,5	49,1	46,6	43,9		

TYPE	P ₂ nom.		3-		Q (m ³ /h - l/min)																			
			P ₁ max kW	A 3x400V 50Hz	0	96	108	120	132	138	144	156	168	180	195	210	225	240	270	300	330			
	HP	kW			0	1600	1800	2000	2200	2300	2400	2600	2800	3000	3250	3500	3750	4000	4500	5000	5500			
100-160B	40	30	31,9	57,1	41,7	40,7	40,8	40,7	40,4	40,3	40,1	39,6	39,1	38,5	37,8	37,0	36,1	35,0	32,3	29,2	25,7			
100-160A	50	37	37,5	70,2	46,0	45,1	45,2	45,1	44,9	44,8	44,7	44,3	43,9	43,3	42,7	42,0	41,1	40,2	37,9	35,0	31,9			



CM-CMG-CMGX-CA-CAX ~ EN 733

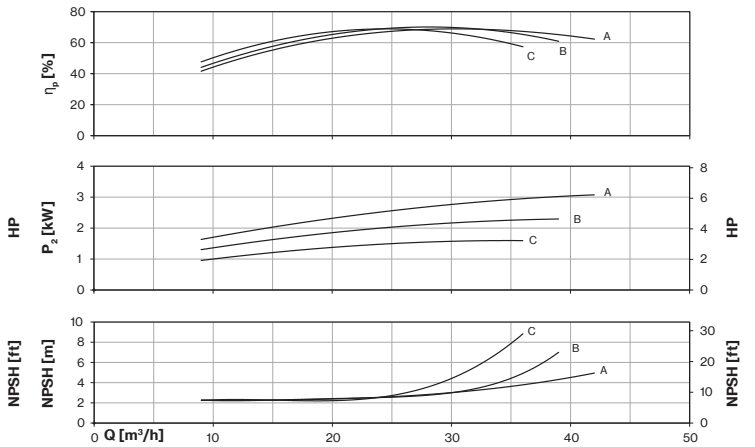
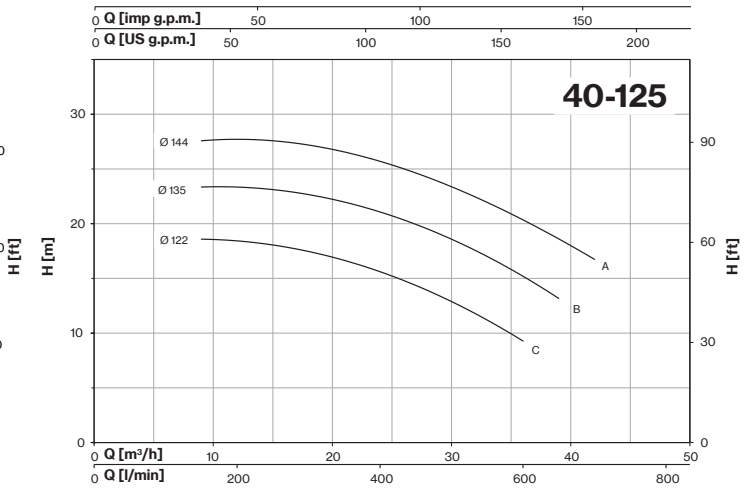
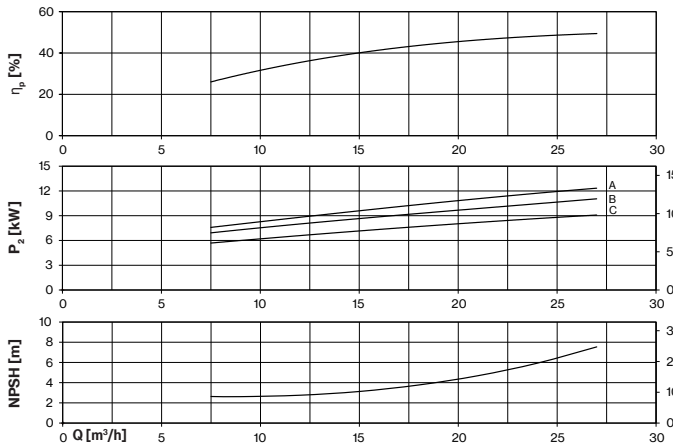
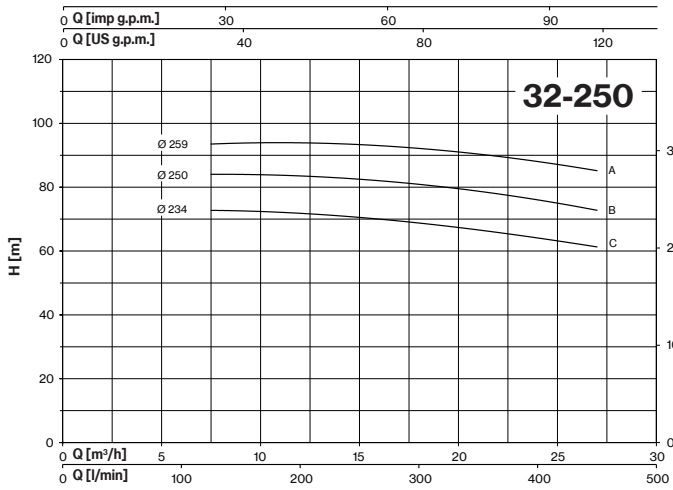
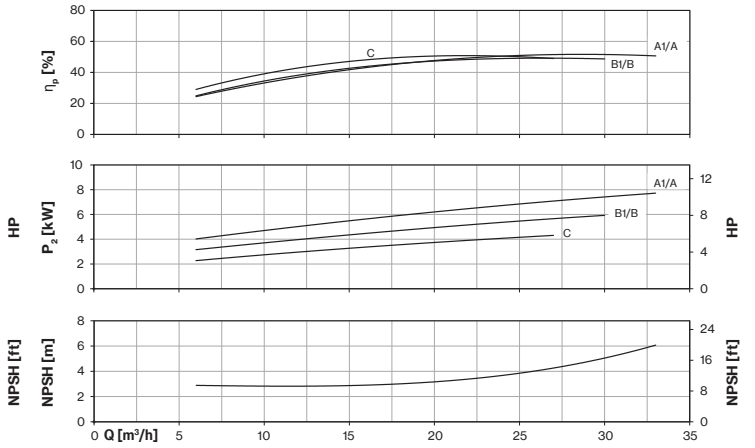
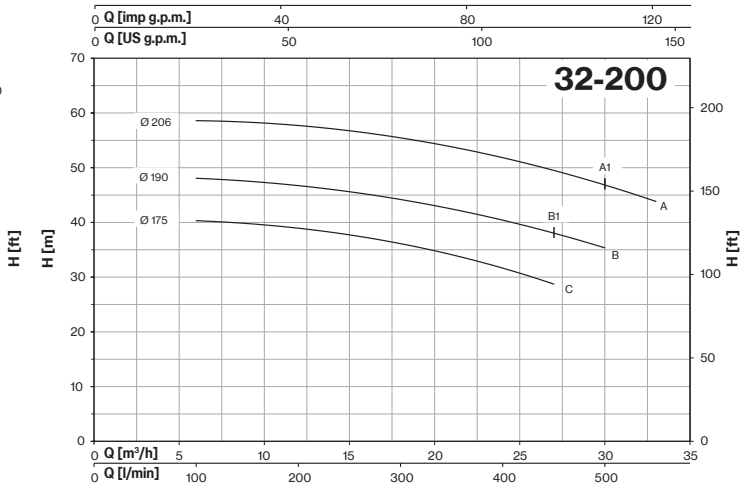
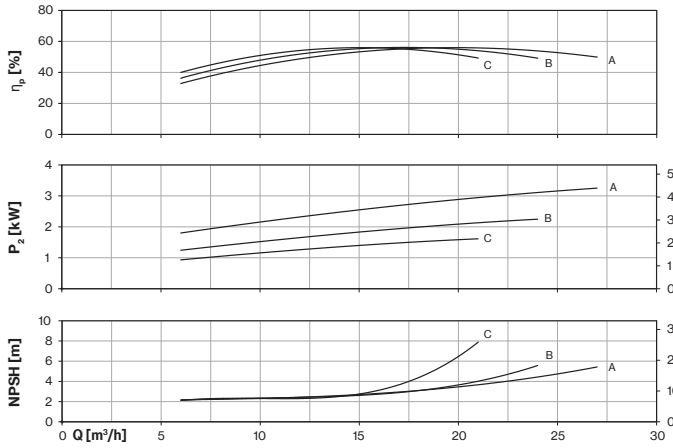
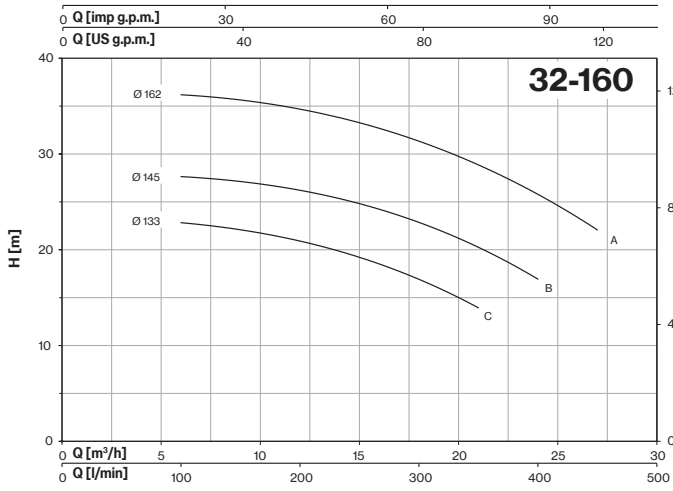

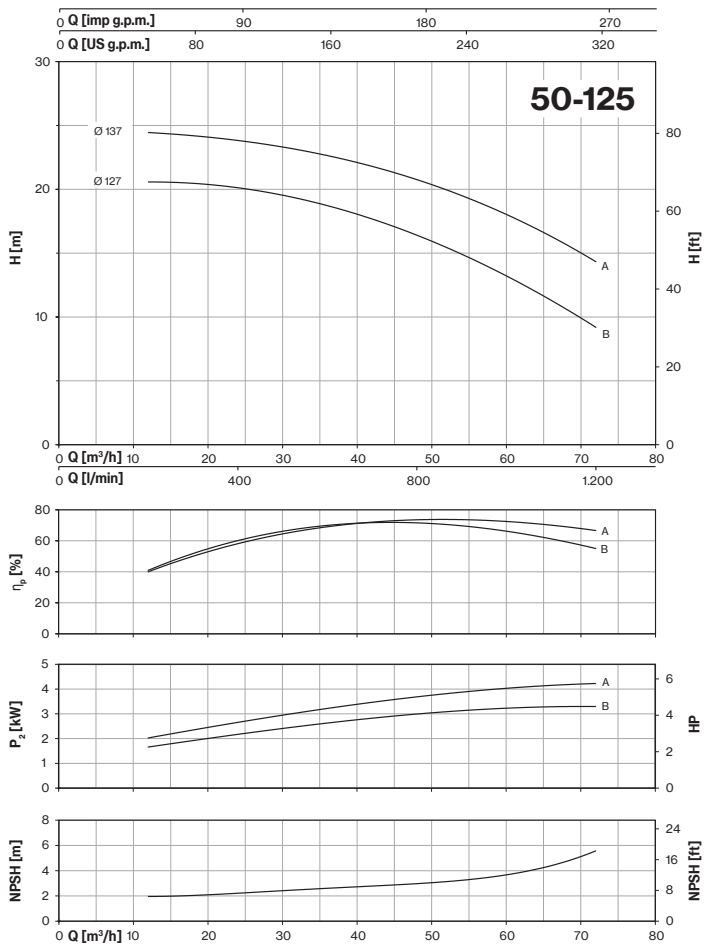
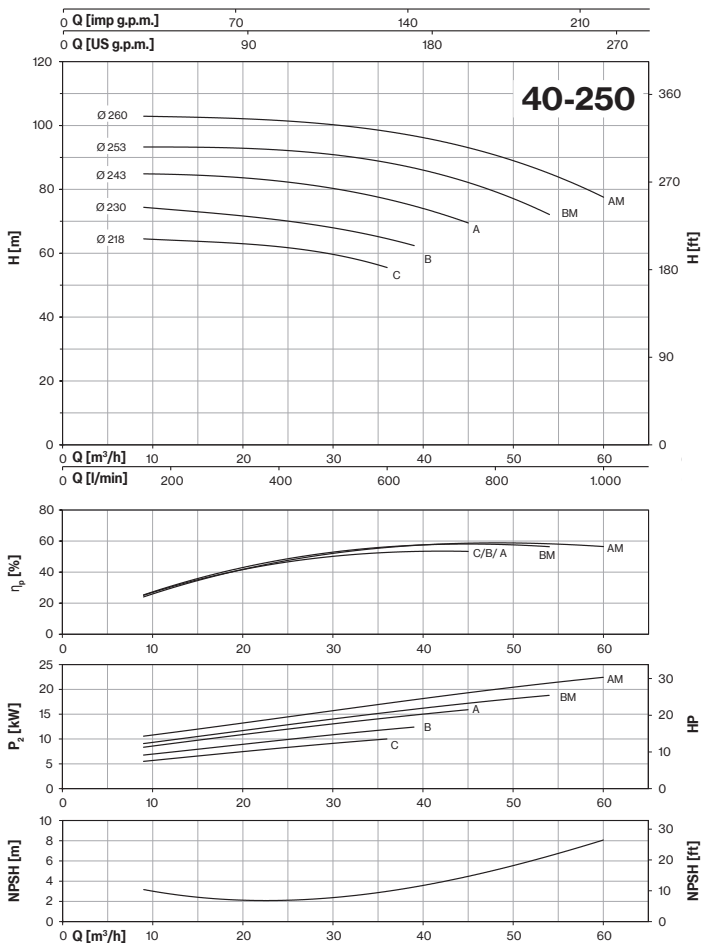
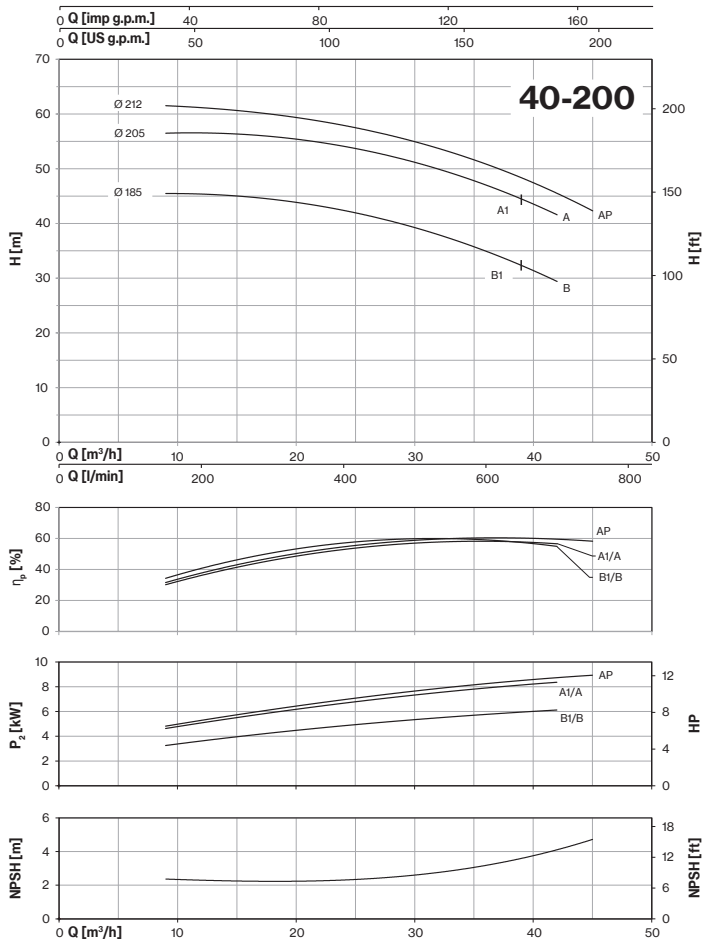
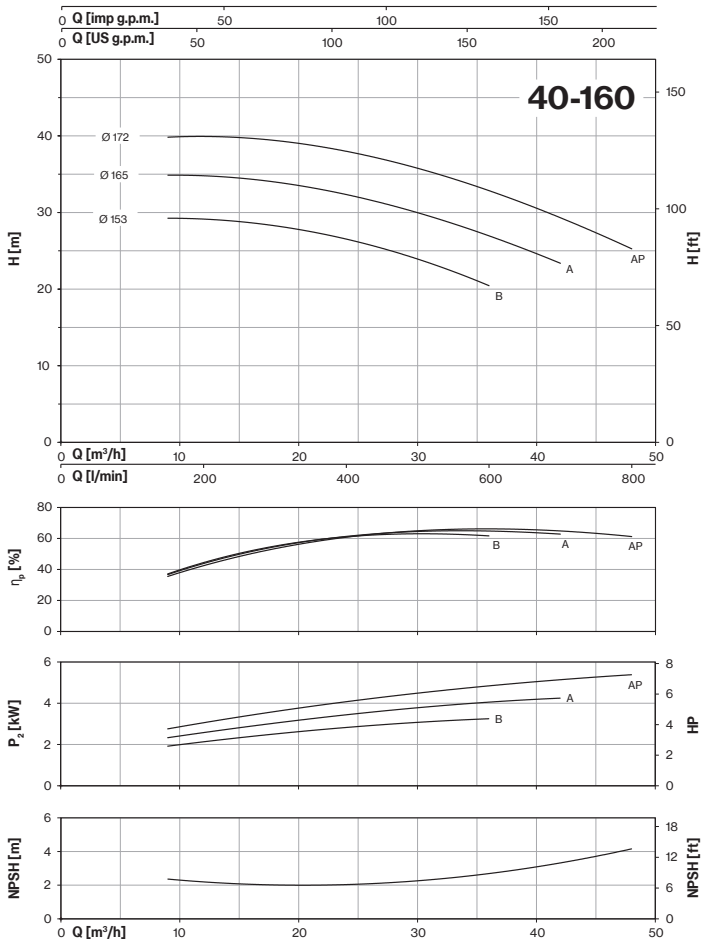

CM-CMG-CMGX-CA-CAX ~ EN 733

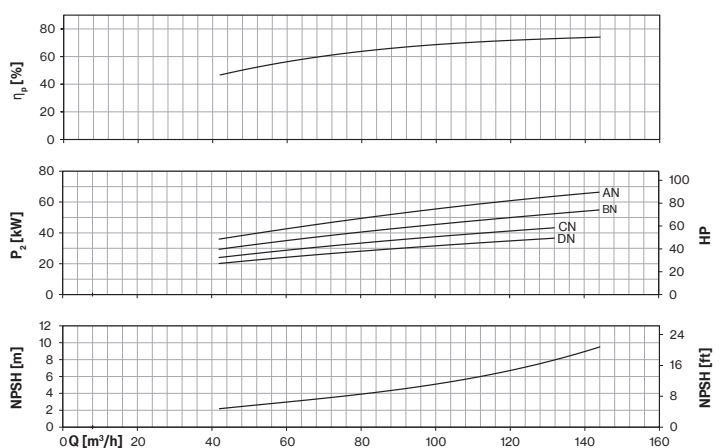
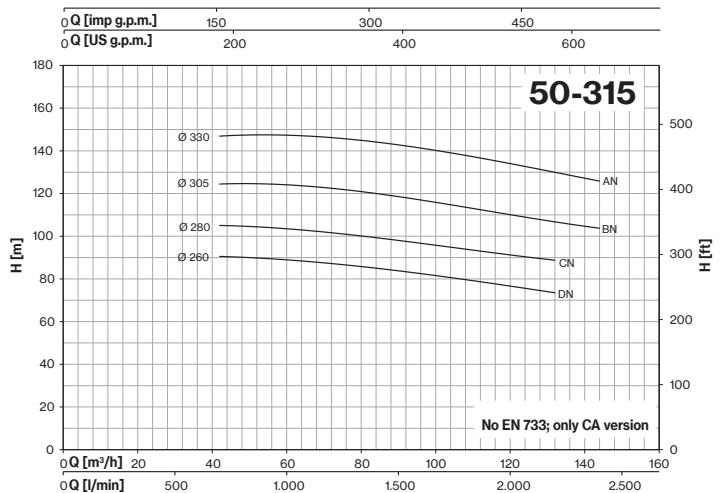
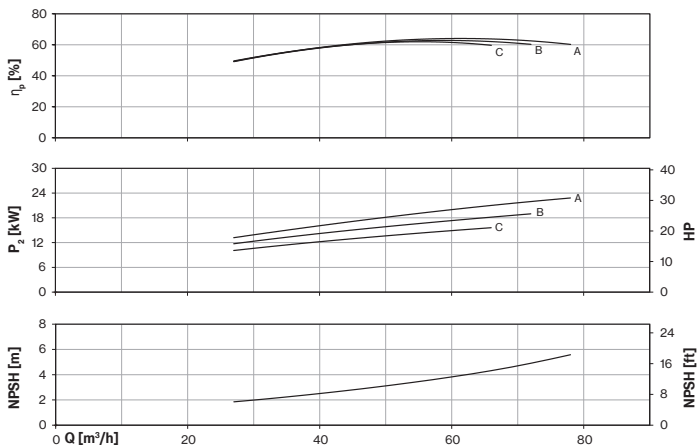
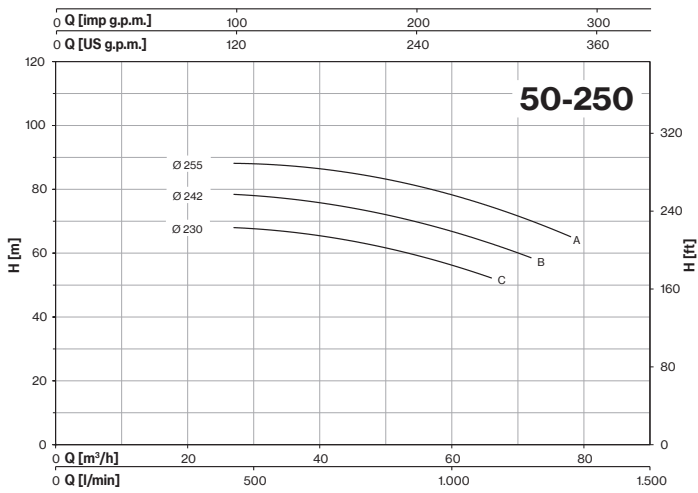
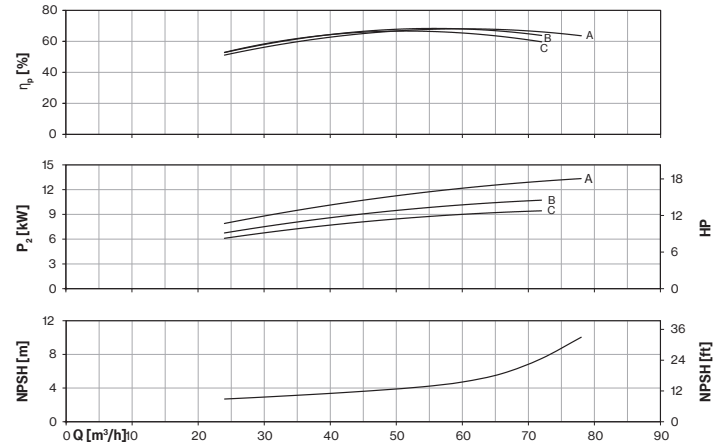
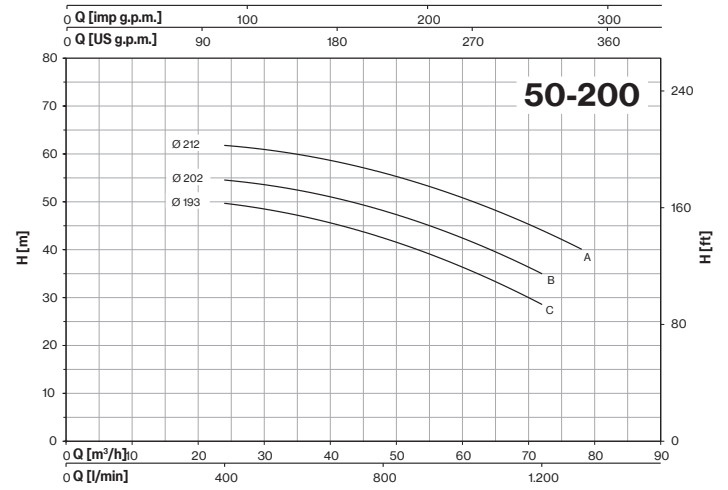
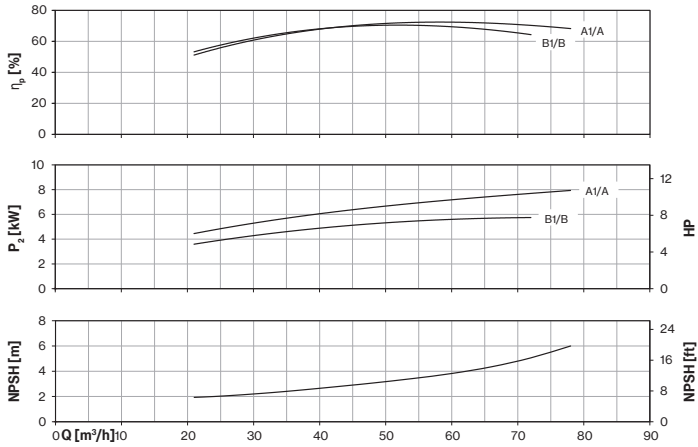
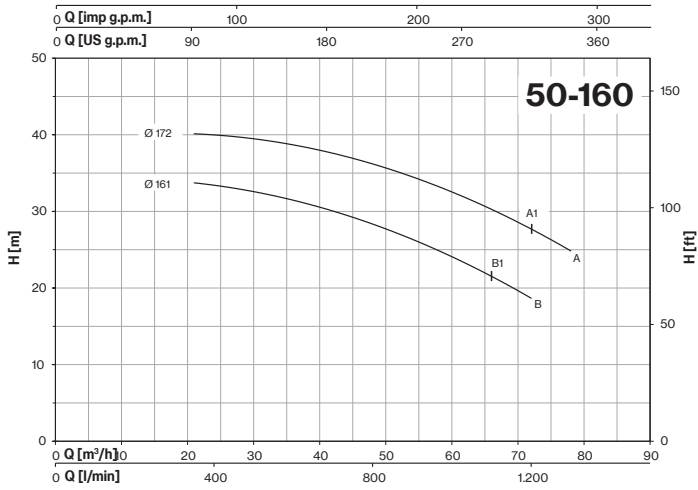

CM-CMG-CMGX-CA-CAX ~ EN 733

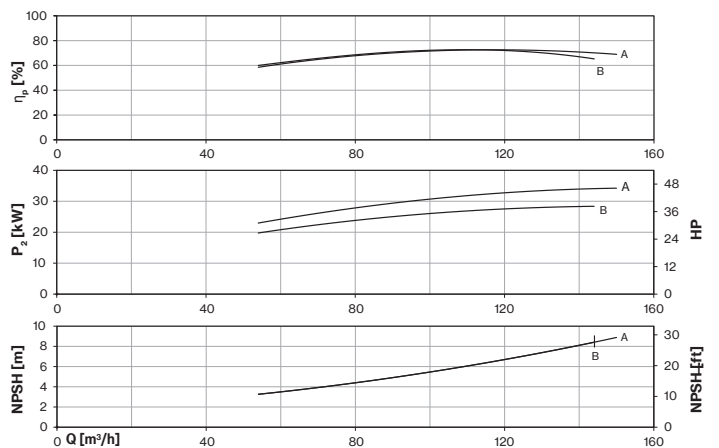
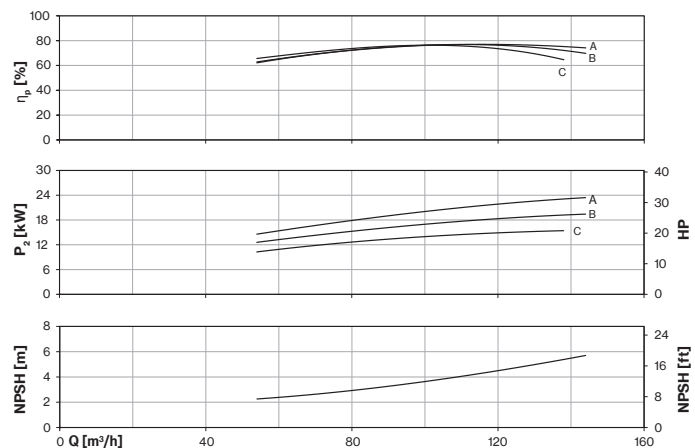
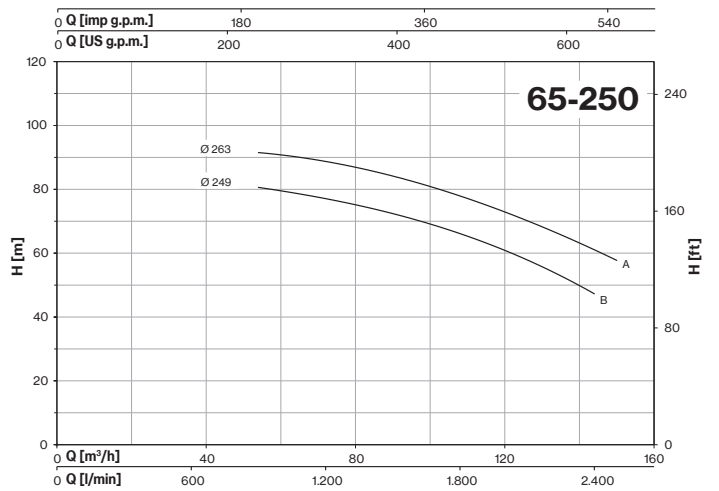
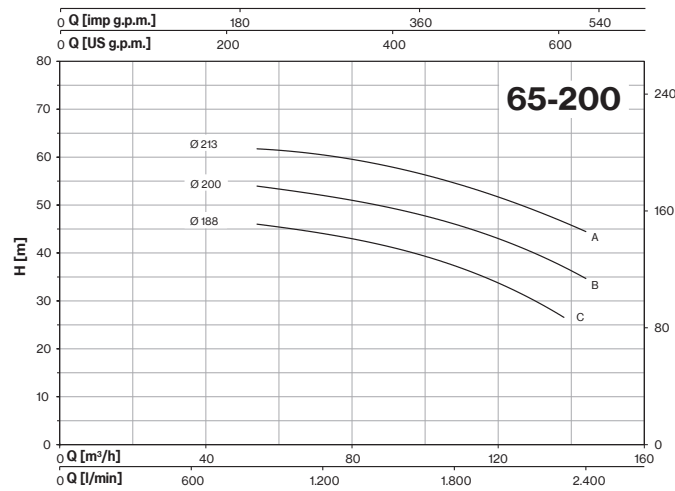
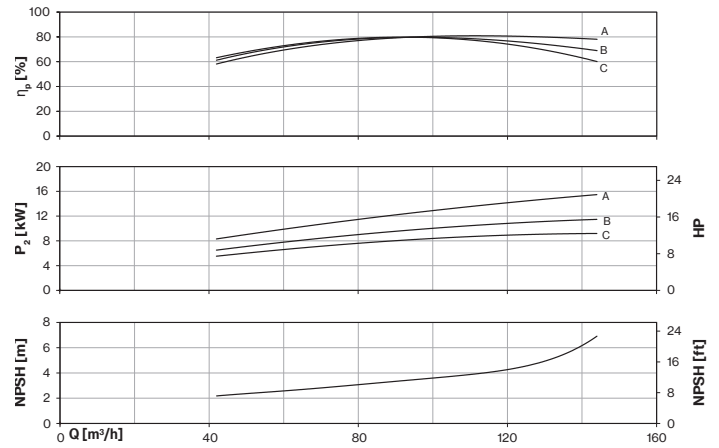
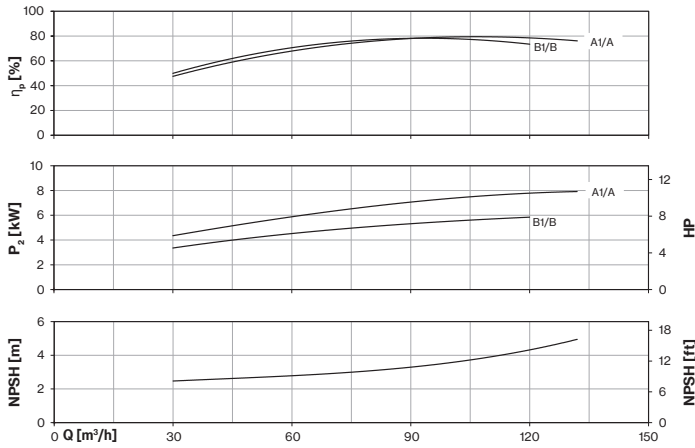
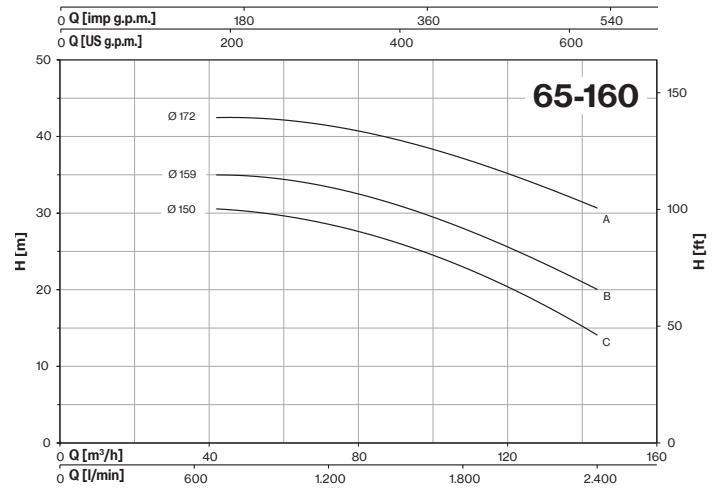
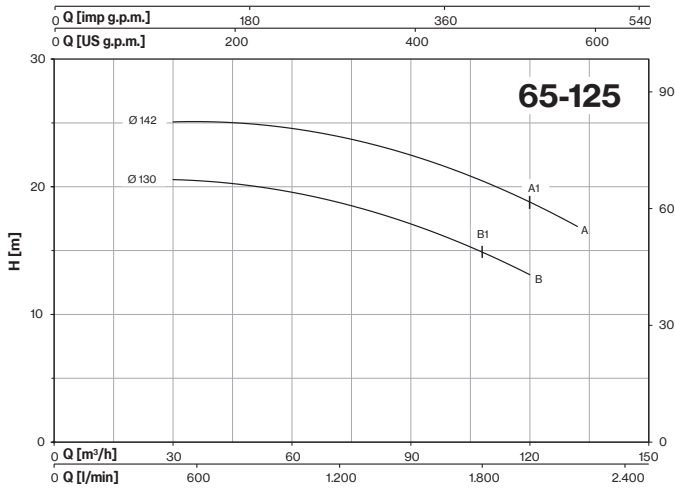

CM-CMG-CMGX-CA-CAX ~ EN 733

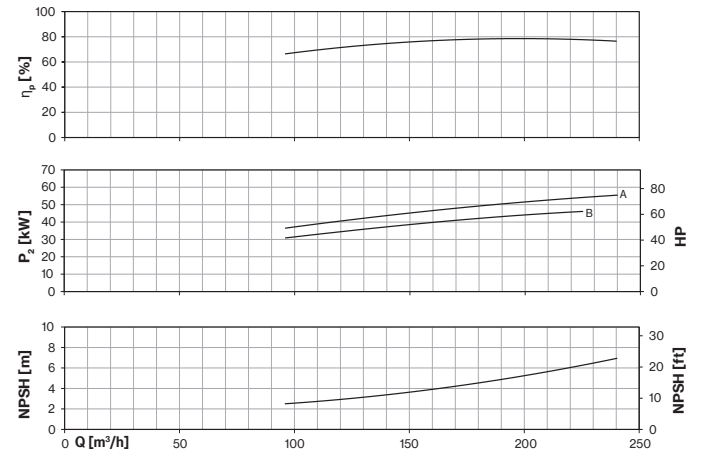
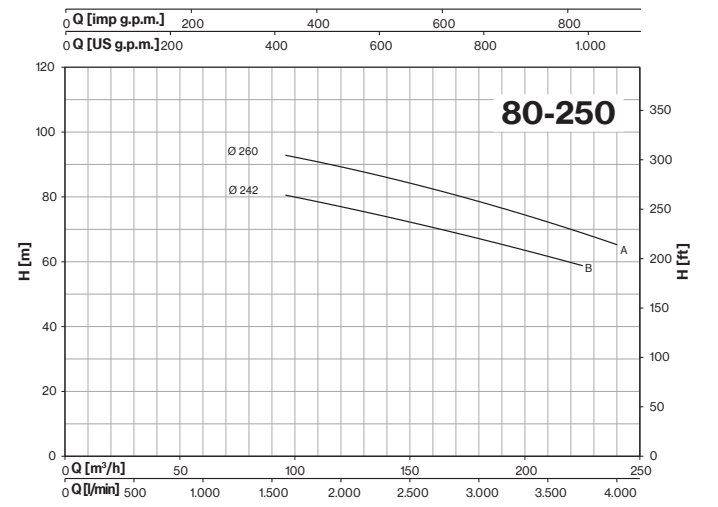
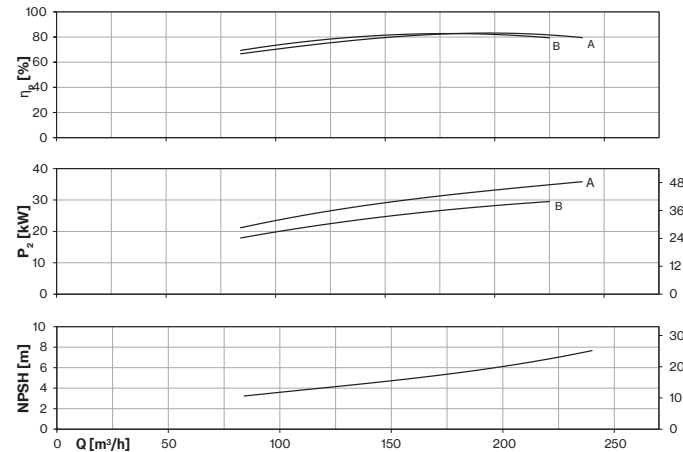
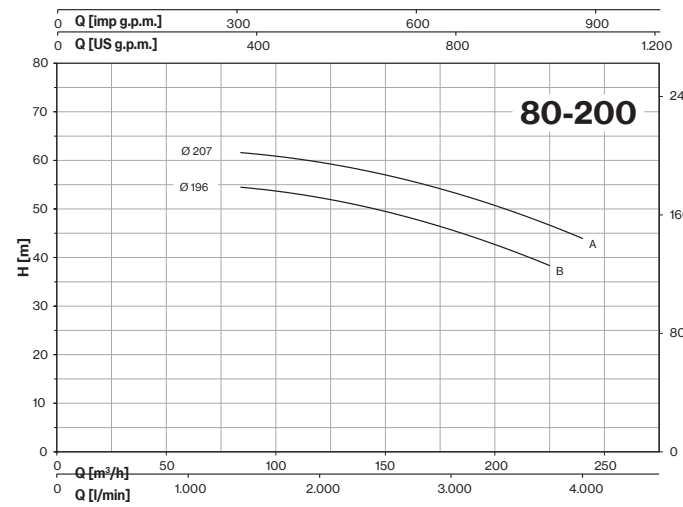
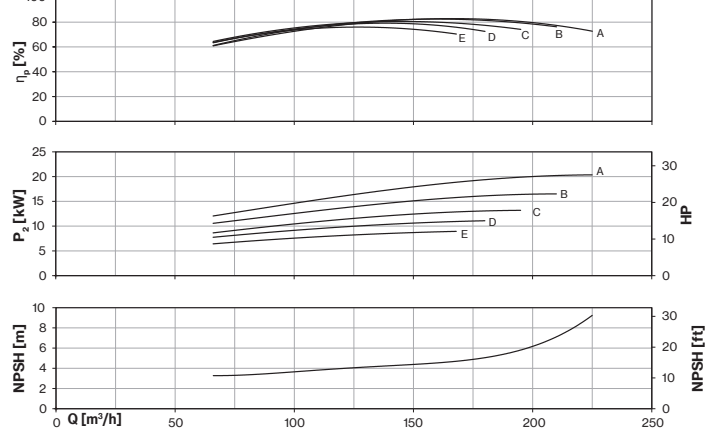
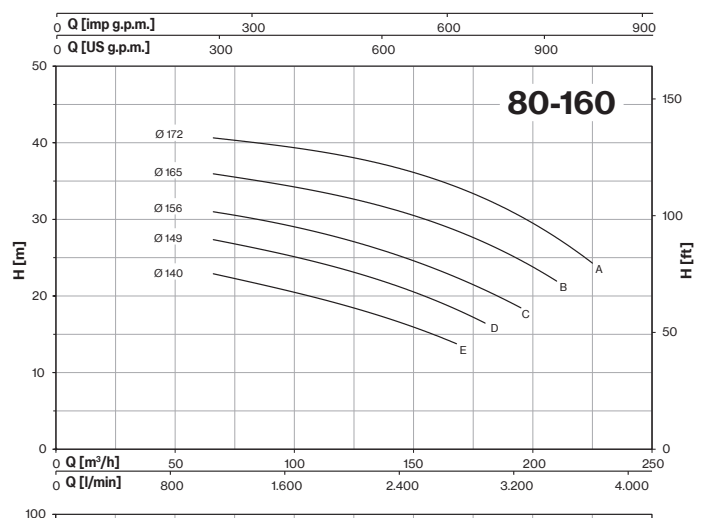
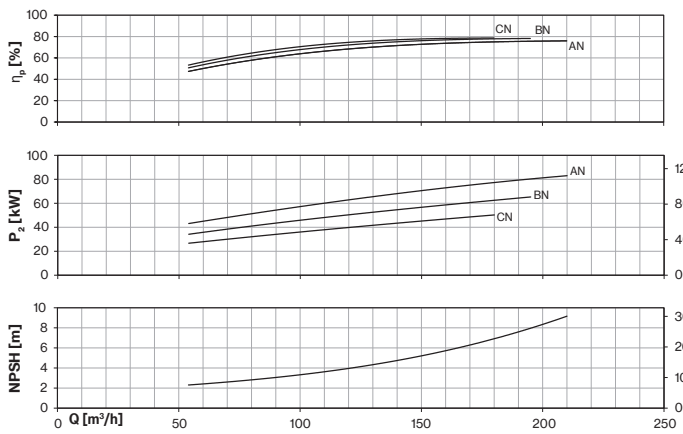
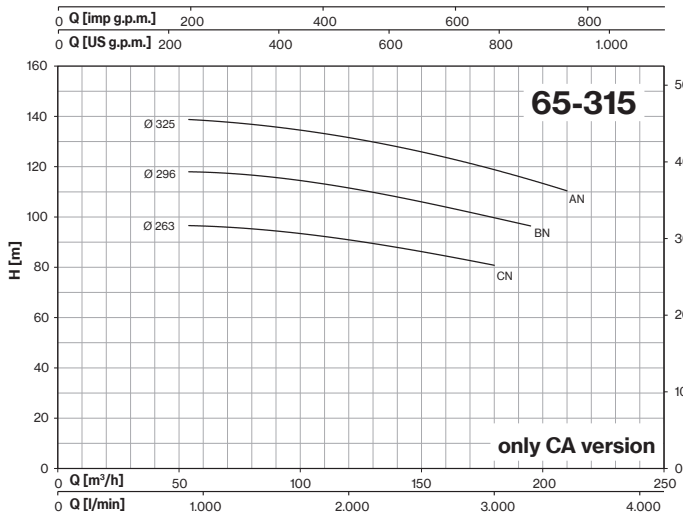

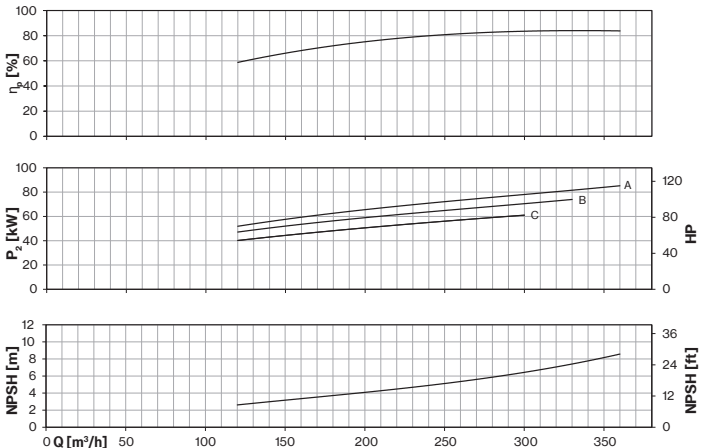
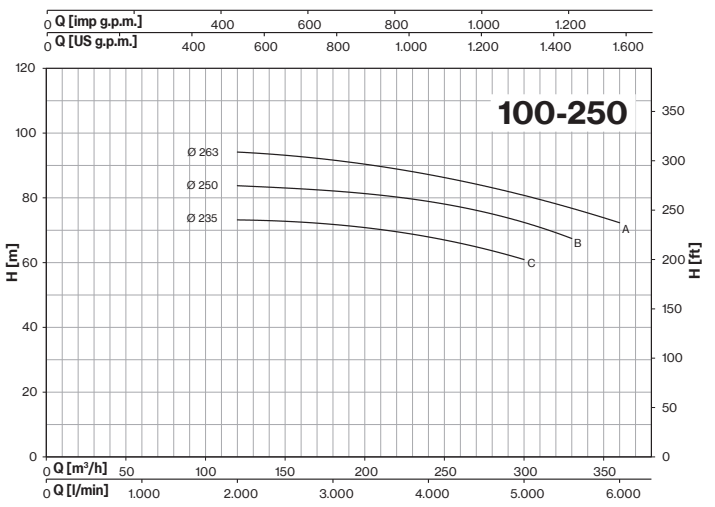
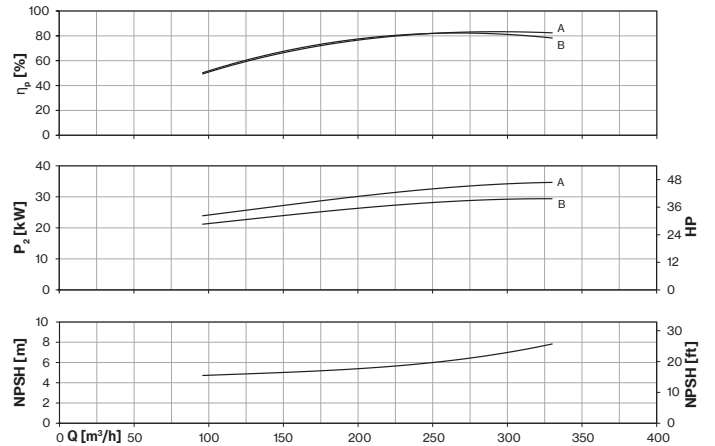
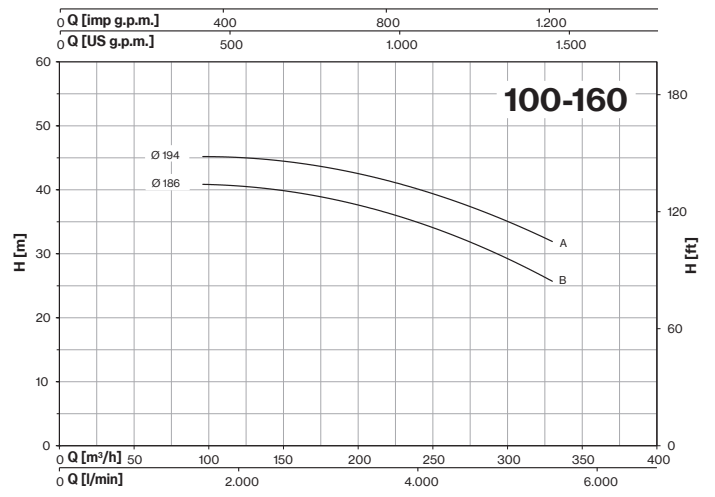
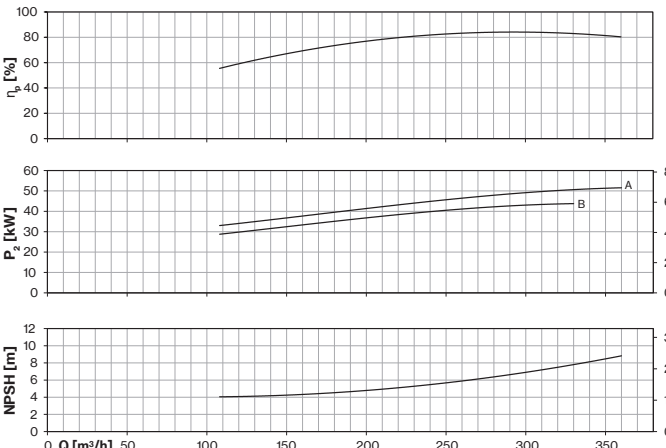
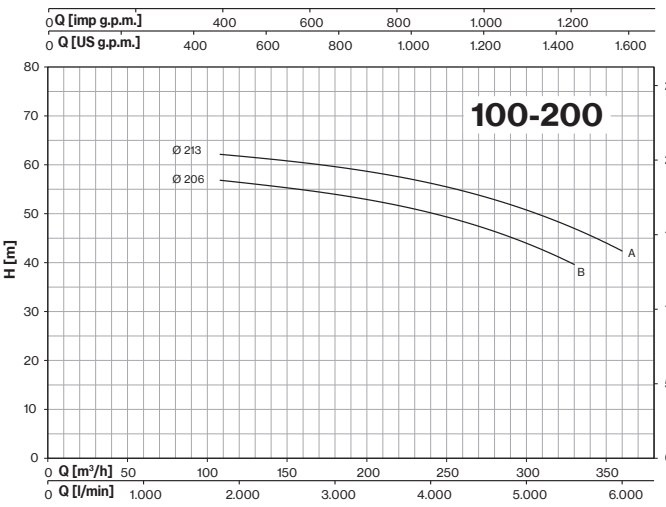
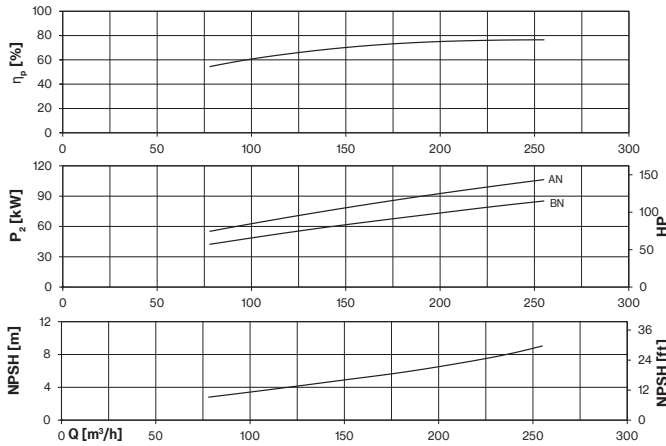
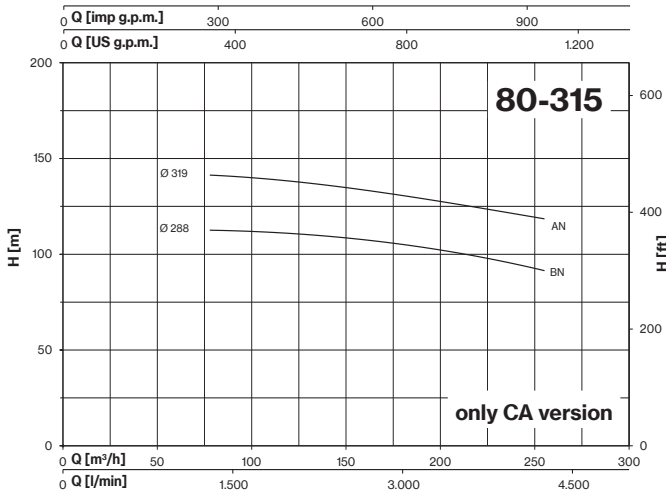

CM-CMG-CMGX-CA-CAX ~ EN 733

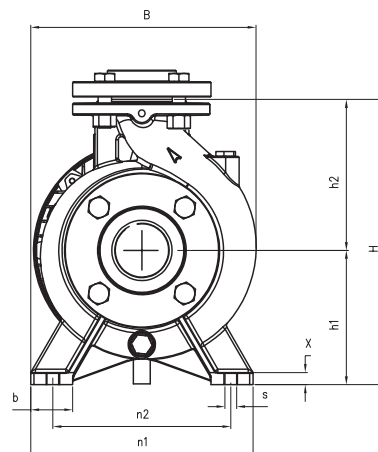
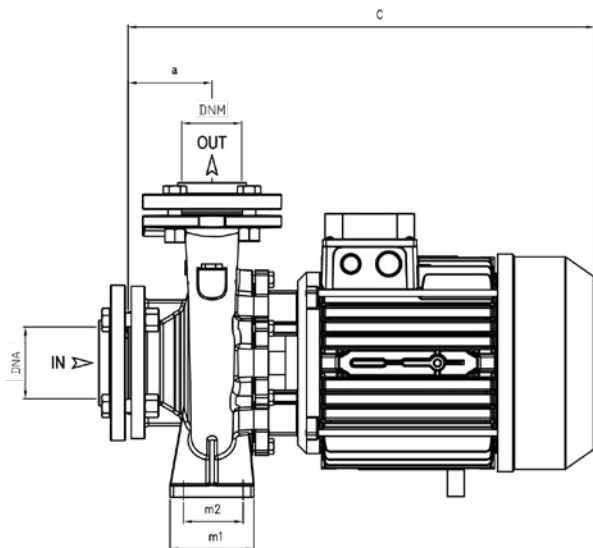





MEC	3~ TYPE	1~ TYPE	DIMENSIONS (mm)															M			Kg
			DNA	DNM	a	h1	h2	m1	m2	n1	n2	b	x	s	C	B	H	I	L	M	
90	32-160 C	32-160 C	50	32	80	132	160	100	70	240	190	50	12	14	530	240	292	551	250	341	41
90	32-160 B	32-160 B			80	132	160	100	70	240	190	50	12	14	530	240	292	551	250	341	44
90	32-160 A				80	132	160	100	70	240	190	50	12	14	530	240	292	551	250	341	47
112		32-200 C			80	160	180	100	70	240	190	50	12	14	574	268	340	602	263	395	65,5
100	32-200 C				80	160	180	100	70	240	190	50	12	14	540	268	340	602	263	395	56,5
132	32-200 B1				80	160	180	100	70	240	190	50	12	14	520	268	340	627	287	408	65,5
132	32-200 B				80	160	180	100	70	240	190	50	12	14	565	268	340	627	287	408	72
132	32-200 A1				80	160	180	100	70	240	190	50	12	14	520	268	340	627	287	408	72
132	32-200 A				80	160	180	100	70	240	190	50	12	14	565	268	340	627	287	408	79
132	32-250 C				100	180	225	125	95	320	250	65	12	14	625	305	405	666	346	471	101,5
132	32-250 B		100	180	225	125	95	320	250	65	14	14	625	305	405	666	346	471	105,5		
160	32-250 A		100	180	225	125	95	320	250	65	14	14	695	305	405	810	354	480	135,5		
90	40-125 C	40-125 C	65	40	80	112	140	100	70	210	160	50	12	14	535	220	252	551	250	341	41,5
90	40-125 B	40-125 B			80	112	140	100	70	210	160	50	12	14	535	220	252	551	250	341	44
90	40-125 A				80	112	140	100	70	210	160	50	12	14	535	220	252	551	250	341	47,5
100		40-160 B			80	132	160	100	70	240	190	50	12	14	535	245	292	551	250	341	56
100	40-160 B				80	132	160	100	70	240	190	50	12	14	535	245	292	551	250	341	52
112		40-160 A			80	132	160	100	70	240	190	50	15	14	579	245	292	602	263	395	64,5
100	40-160 A				80	132	160	100	70	240	190	50	15	14	535	245	292	602	263	395	56,5
112	40-160 AP				80	132	160	100	70	240	190	50	15	14	579	245	292	627	287	408	63
112	40-200 B1				100	160	180	100	70	265	212	50	15	14	597	273	340	627	287	408	68
132	40-200 B				100	160	180	100	70	265	212	50	15	14	590	273	340	627	287	408	74,5
112	40-200 A1		100	160	180	100	70	265	212	50	15	14	597	273	340	627	287	408	74		
132	40-200 A		100	160	180	100	70	265	212	50	15	14	590	273	340	627	287	408	81		
132	40-200 AP		100	160	180	100	70	265	212	50	15	14	628	273	340	666	346	471	93,5		
132	40-250 C		100	180	225	125	95	320	250	65	15	14	630	322	405	666	346	471	100,5		
132	40-250 B		100	180	225	125	95	320	250	65	15	14	630	322	405	666	346	471	105		
160	40-250 A		100	180	225	125	95	320	250	65	15	14	700	322	405	810	354	480	135		
132	40-250 BM		100	180	225	125	95	320	250	65	15	14	750	332	405	810	354	480	150		
160	40-250 AM		100	180	225	125	95	320	250	65	15	14	750	332	405	810	354	480	160,5		
100		50-125 B	65	50	100	132	160	100	70	240	190	50	12	14	525	250	292	602	263	395	57,5
100	50-125 B				100	132	160	100	70	240	190	50	12	14	560	250	292	602	263	395	53,5
112		50-125 A			100	132	160	100	70	240	190	50	12	14	610	250	292	602	263	395	65,5
100	50-125 A				100	132	160	100	70	240	190	50	12	14	560	250	292	602	263	395	57,5
112	50-160 B1				100	160	180	100	70	265	212	50	12	14	597	270	340	627	287	408	68,5
132	50-160 B				100	160	180	100	70	265	212	50	12	14	590	270	340	627	287	408	74,5
112	50-160 A1				100	160	180	100	70	265	212	50	12	14	597	270	340	627	287	408	74,5
132	50-160 A				100	160	180	100	70	265	212	50	12	14	590	270	340	627	287	408	81
132	50-200 C				100	160	200	100	70	265	212	50	12	14	635	290	360	666	346	471	98
132	50-200 B				100	160	200	100	70	265	212	50	12	14	635	290	360	666	346	471	102,5
160	50-200 A		100	160	200	100	70	265	212	50	12	14	705	290	360	810	354	480	132,5		
160	50-250 C		100	180	225	125	95	320	250	65	14	14	705	332	405	810	354	480	139		
160	50-250 B		100	180	225	125	95	320	250	65	14	14	750	332	405	810	354	480	154		
160	50-250 A		100	180	225	125	95	320	250	65	14	14	750	332	405	810	354	480	164		

MEC	3- TYPE	1- TYPE	DIMENSIONS (mm)																		
			DNA	DNM	a	h1	h2	m1	m2	n1	n2	b	x	s	C	B	H			I	L
112	65-125 B1		80	65	100	160	180	125	95	280	212	65	14	14	612	280	340	627	287	408	70
132	65-125 B				100	160	180	125	95	280	212	65	14	14	605	280	340	627	287	408	76,5
112	65-125 A1				100	160	180	125	95	280	212	65	14	14	612	280	340	627	287	408	76,5
132	65-125 A				100	160	180	125	95	280	212	65	14	14	605	280	340	627	287	408	83
132	65-160 C				100	160	200	125	95	280	212	65	14	14	635	290	360	666	346	471	99,5
132	65-160 B				100	160	200	125	95	280	212	65	14	14	635	290	360	666	346	471	103,5
160	65-160 A				100	160	200	125	95	280	212	65	14	14	705	290	360	810	354	480	135
160	65-200 C				100	180	225	125	95	320	250	65	14	14	705	330	405	810	354	480	138,5
160	65-200 B				100	180	225	125	95	320	250	65	14	14	750	330	405	810	354	480	153
160	65-200 A				100	180	225	125	95	320	250	65	14	14	750	330	405	810	354	480	163,5
180	65-250 B				100	200	250	160	120	360	280	80	16	19	820	370	450	920	420	625	203,5
180	65-250 A				100	200	250	160	120	360	280	80	16	19	860	370	450	920	420	625	226
132	80-160 E		100	80	125	180	225	125	95	320	250	65	14	14	665	330	405	810	354	480	110
132	80-160 D				125	180	225	125	95	320	250	65	14	14	665	330	405	810	354	480	114
160	80-160 C				125	180	225	125	95	320	250	65	14	14	735	330	405	810	354	480	143
160	80-160 B				125	180	225	125	95	320	250	65	14	14	780	330	405	810	354	480	157,5
160	80-160 A				125	180	225	125	95	320	250	65	14	14	780	330	405	810	354	480	168
180	80-200 B				125	180	250	125	95	345	280	65	16	14	840	355	430	920	420	625	200
180	80-200 A				125	180	250	125	95	345	280	65	16	14	880	355	430	920	420	625	222
180	100-160 B				125	100	125	200	280	160	120	360	280	80	18	18	842	390	480	920	420
180	100-160 A		125	200			280	160	120	360	280	80	18	18	882	390	480	920	420	625	230,5

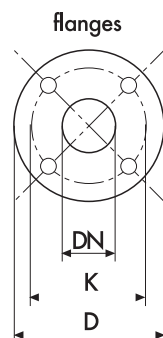
DIMENSIONS (mm)				
DN	D	K	holes	
			n°	Ø
32	140	100	4	18
40	150	110	4	18
50	165	125	4	18
65	185	145	4	18
80	200	160	8	18
100	220	180	8	18
125	250	210	8	18



CM Serie-Mechanical seal and bearings

MECHANICAL SEAL	PUMP MODEL	SHAFT Ø		STANDARD MATERIAL	OPTIONAL			
	CM32-160C, CM32-160B, CM32-160A, CM40-125C, CM40-125B, CM40-125A	20mm	Rotating face Stationary face Elastomer	Ceramic Graphite NBR	Ceramic Graphite EPDM	- - -	SiC SiC EPDM	SiC SiC FKM
	CM40-250BM, CM40-250AM	28mm	Rotating face Stationary face Elastomer	Ceramic Graphite EPDM	- - -	- - -	SiC SiC EPDM	SiC SiC FKM
	CM32-200C, CM32-200B1, CM32-200B, CM32-200A1, CM32-200A, CM32-250C, CM32-250B, CM32-250A, CM40-160B, CM40-160A, CM40-160AP, CM40-200B1, CM40-200B, CM40-200A1, CM40-200A, CM40-200AP, CM40-250C, CM40-250B, CM40-250A, CM50-125B, CM50-125A, CM50-160B1, CM50-160B, CM50-160A1, CM50-160A, CM50-200C, CM50-200B, CM50-200A, CM50-250C, CM50-250B, CM50-250A, CM65-125B1, CM65-125B, CM65-125A1, CM65-125A, CM65-160C, CM65-160B, CM65-160A, CM65-200C, CM65-200B, CM65-200A, CM80-160E, CM80-160D, CM80-160C, CM80-160B, CM80-160A	28mm	Rotating face Stationary face Elastomer	Ceramic Graphite NBR	Ceramic Graphite EPDM	Ceramic Graphite FKM	SiC SiC EPDM	SiC SiC FKM
	CM65-250B, CM65-250A, CM80-200B, CM80-200A, CM100-160B, CM100-160A	40mm	Rotating face Stationary face Elastomer	CrNi-steel Graphite NBR	CrNi-steel Graphite EPDM	CrNi-steel Graphite FKM	SiC SiC EPDM	SiC SiC FKM

BEARINGS	PUMP MODEL	TYPE	
	3-CM32-200C, CM40-160B, 3-CM40-160A, CM50-125B, 3-CM50-125A	6204-ZZ	6206-ZZ C3
	CM32-160C, CM32-160B, CM32-160A, CM40-125C, CM40-125B, CM40-125A	6205-ZZ C3	6203-ZZ
	1-CM32-200C, CM32-200B1, CM32-200B, CM32-200A1, CM32-200A, CM32-250C, CM32-250B, 1-CM40-160A, CM40-160AP, CM40-200B1, CM40-200B, CM40-200A1, CM40-200A, CM40-200AP, CM40-250C, CM40-250B, 1-CM50-125A, CM50-160B1, CM50-160B, CM50-160A1, CM50-160A, CM50-200C, CM50-200B, CM65-125B1, CM65-125B, CM65-125A1, CM65-125A, CM65-160C, CM65-160B, CM80-160E, CM80-160D	6206-ZZ C3	6306-ZZ C3
	CM32-250A, CM40-250A, CM40-250BM, CM40-250AM, CM50-200A, CM50-250C, CM50-250B, CM50-250A, CM65-160A, CM65-200C, CM65-200B, CM65-200A, CM80-160C, CM80-160B, CM80-160A	6308-ZZ C3	6309-ZZ C3
	CM65-250B, CM65-250A, CM80-200B, CM80-200A, CM100-160B, CM100-160A	6309-ZZ C3	6310-ZZ C3